

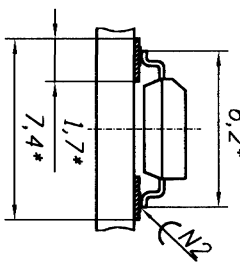

Инв. N подл.	Порл. и дата	Взom. инв. N	Инв. N зуб.	Порл. и дата



Установка ДАЗ  
поз.28,30  
(5:1)



Вариант установки ДАЗ  
поз.29

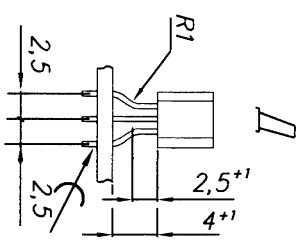

Установка ДА1  
5:1

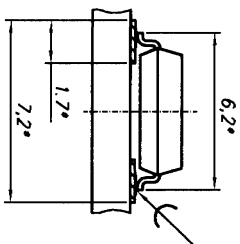

В(3)  
Установка ДАЗ

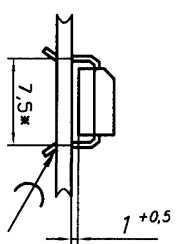

Установка L2

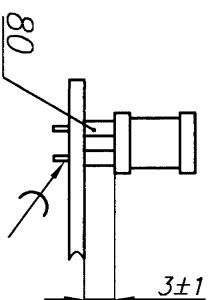

Установка L1

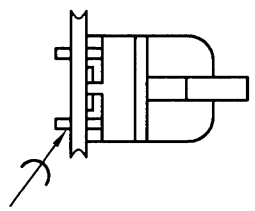

Установка FU1

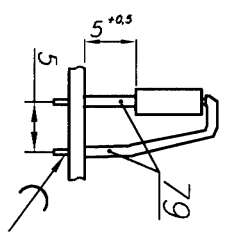

Установка VD3

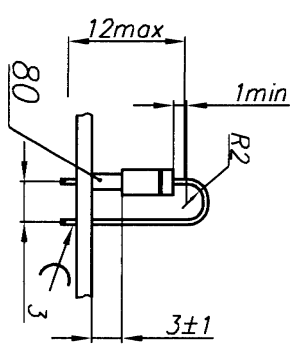

Установка VD2, VD5

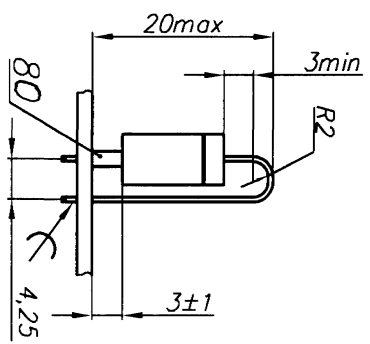

Иж.	Пусм	N	вожм.	Порл.	Дата

Установка С2      Установка С3, С8      Установка С7      Установка С4...С6, С10      Установка С1

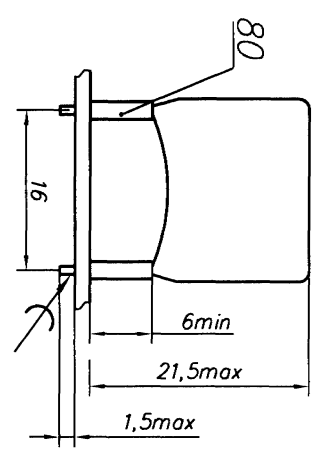
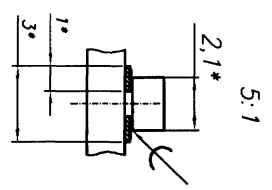
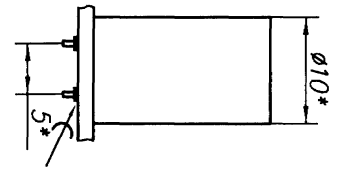
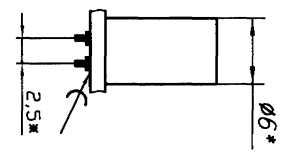
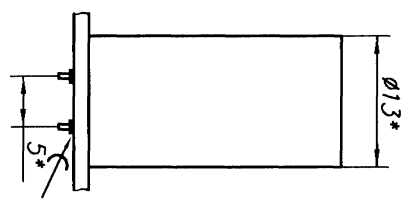

Установка R2...R4  
5:1

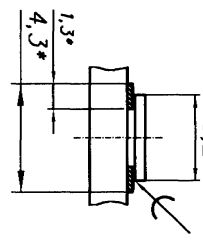

Установка R6...R8, R16, R17  
5:1

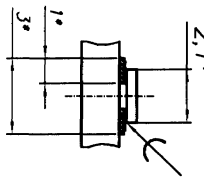

Установка VD1  
5:1

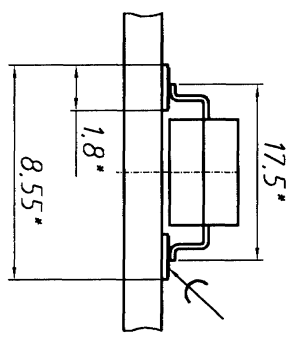

Установка VD4  
5:1

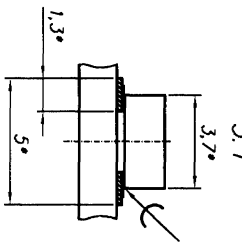

Установка R13  
E

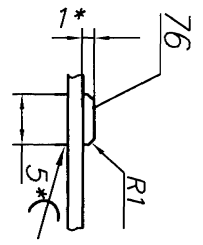

E

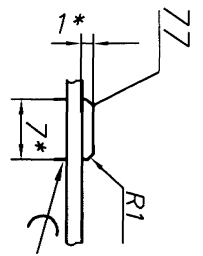

Установка R1

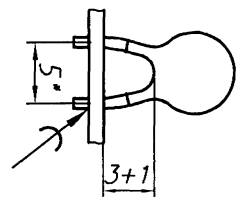

Б(1) 2место

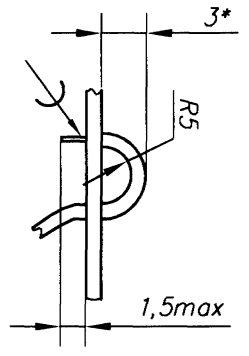

Установка С9

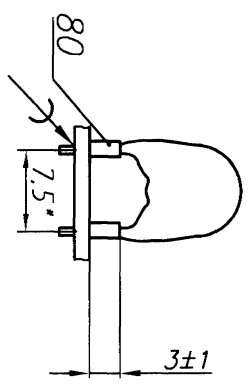

Инв. N подл.	Подр. и дата	Взам.инв. N	Инв. N дуб.	Подр. и дата

Иж	Лист	N докум.	Подр.	Дат

АВЛГ 485.31.00-2705